

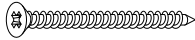









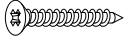

Instrução de Montagem

LOJA **Rudnick**

www.lojarudnick.com.br

Acessórios

A	18201442		4,0 x 50	12
B	18201508		4,0 x 30	04
C	18200142		4,0 x 30	09
D	18201339		4,0 x 14	36
E	18401122		3,5 x 12	16
F	10500001		Ø6,0 x 30	12
G	16420725		Puxador	02
H	18306292		Cor Pina Tapa Furo 12mm	28
I	18306085		Cor Branco Tapa Furo 12mm	12
J	18509797		Dobradiça Alta	06
K	18302608		Prego 10 x 10	30
L	18302608		Sapata	08

Armário Flex

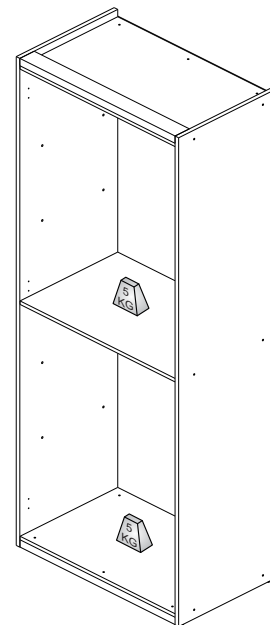
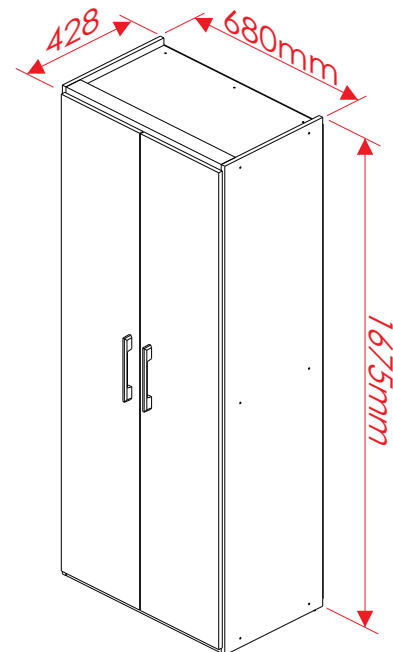

Atenção!

Pesos máximos recomendados com cargas uniformemente distribuídas.

Utilizar a régua abaixo para medir os acessórios.



Componentes

N.	Componentes	Código	Quant.
01	Tampo/Fundo	T18320	02
02	Lateral	L09102	02
03	Tampo Intermediário	T18326	01
04	Travessa Frontal/Traseira	X17285	03
05	Traseira	F06079	01
06	Porta	P23537	02



Atenção!

Forrar o chão com o papelão das embalagens para efetuar a montagem

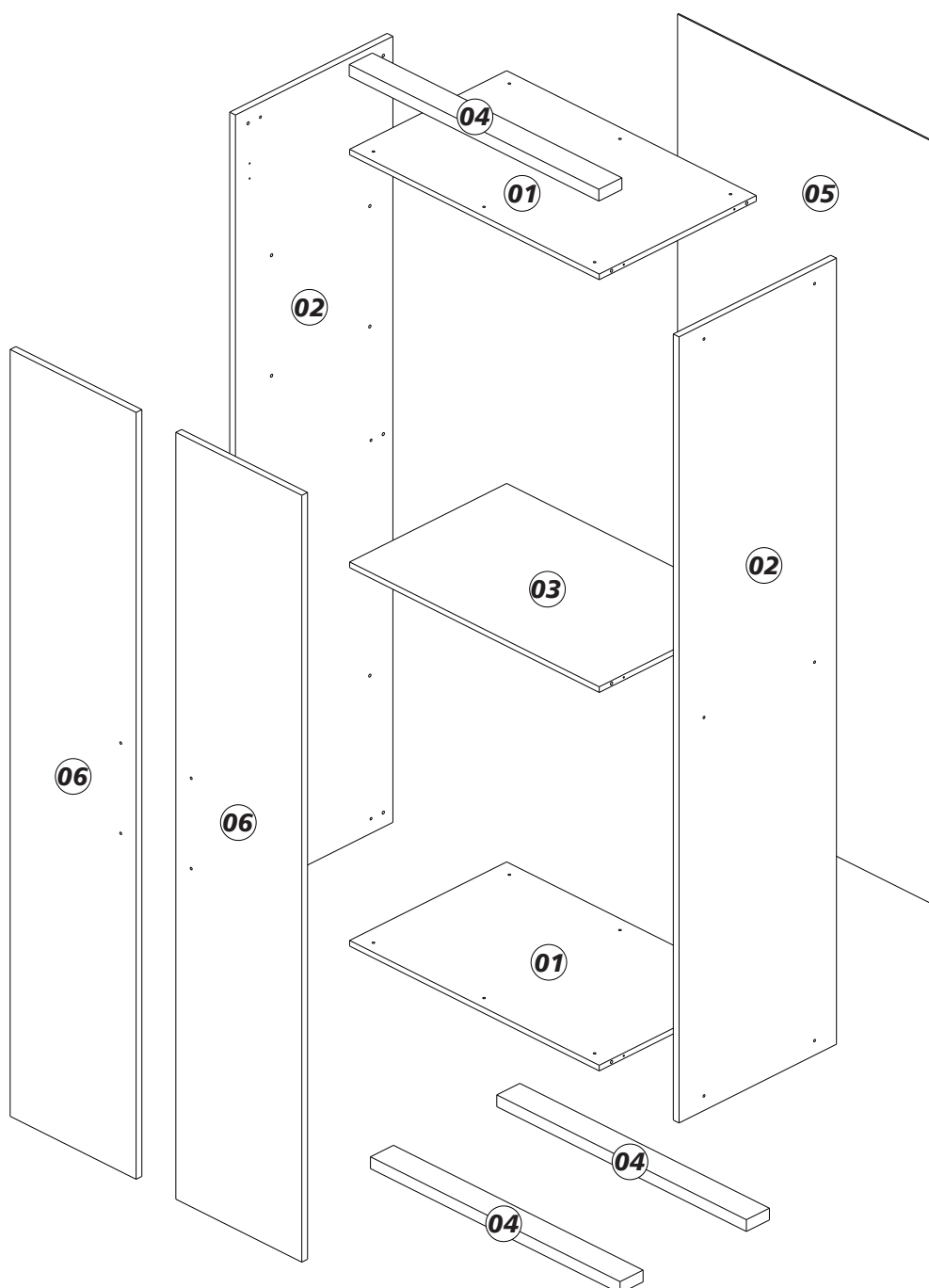
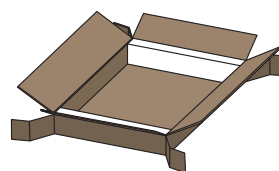

Componentes - Peças

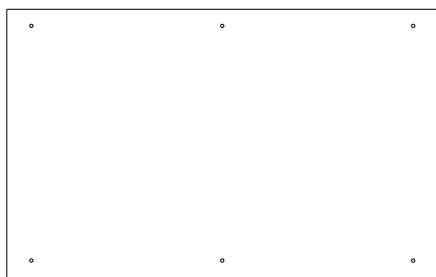

01 - 650x409x12mm - 2x

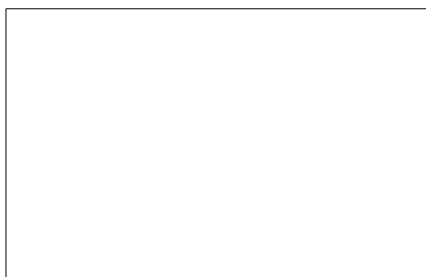

03 - 650x409x12mm - 1x

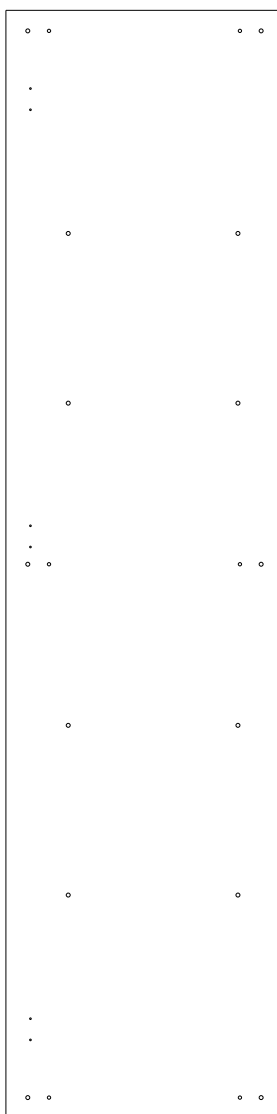

02 - 1671x410x15mm - 2x



04 - 650x60x25mm - 3x

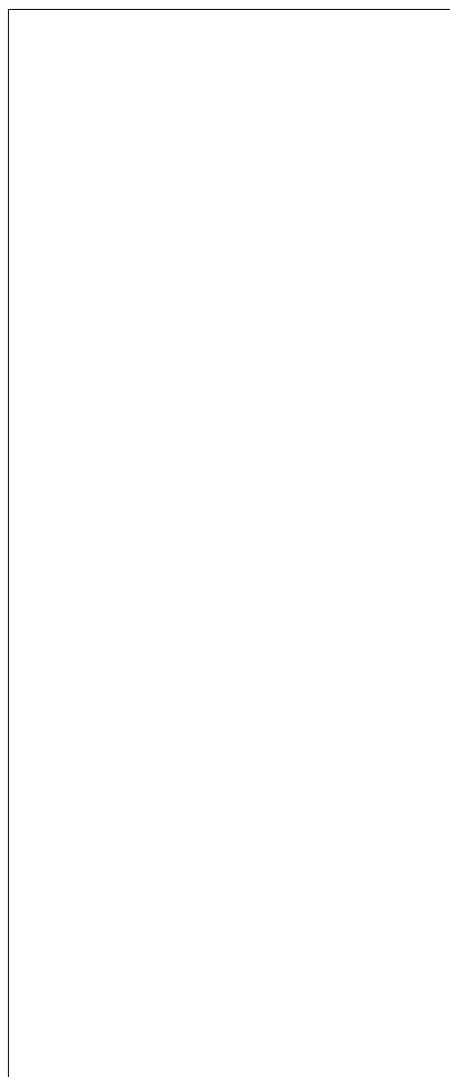

05 - 1621x678x2,8mm - 1x

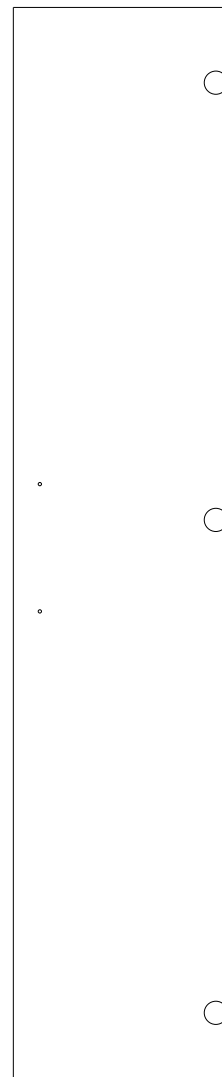

06 - 1630x328x15mm - 2x

Opções de Montagem

Atenção!

Este armário possui algumas opções de montagem que estão disponíveis abaixo. Após escolher a opção desejada, escaneie o código QR para acessar o esquema de montagem.

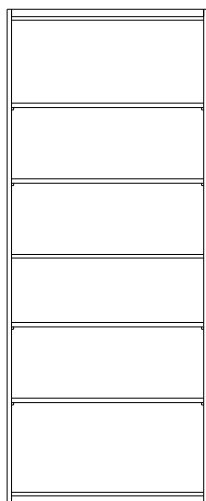

Caso tenha adquirido a versão 5 Prateleiras, acesse o esquema de montagem com o código QR ao lado.

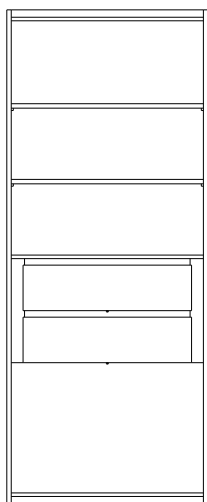

Caso tenha adquirido a versão 3 Prateleiras e 2 Gavetas, acesse o esquema de montagem com o código QR ao lado.

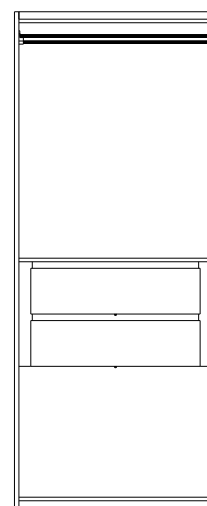

Caso tenha adquirido a versão com 2 Gavetas e 1 Cabideiro, acesse o esquema de montagem com o código QR ao lado.

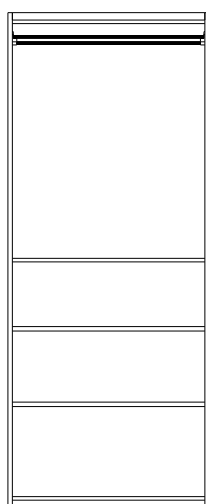

Caso tenha adquirido a versão 3 Prateleiras e 1 cabideiro, acesse o esquema de montagem com o código QR ao lado.

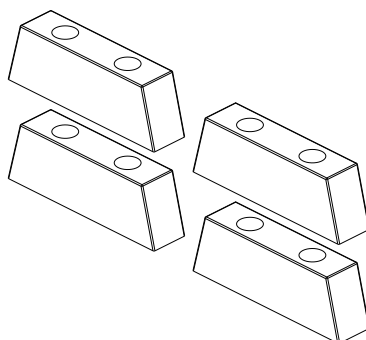

Caso tenha adquirido a versão com pés, acesse o esquema de montagem dos pés com o código QR ao lado.

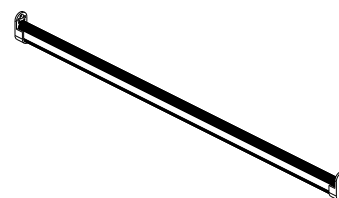

Caso tenha adquirido a versão com 1 Cabideiro acesse o esquema de montagem de instalação do kit cabide com o código QR ao lado.

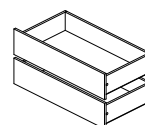

Caso tenha adquirido a versão 2 gavetas, acesse o esquema de montagem com o código QR ao lado.



Atenção!

Para acessar o vídeo de montagem, você deve abrir a câmera do seu celular e apontá-la para o código QR ao lado.

