

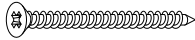









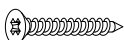

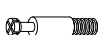









# Instrução de Montagem

LOJA **Rudnick**

www.lojarudnick.com.br

## Acessórios

<b>A</b>	18201442		4,0 x 50	20
<b>B</b>	18201506		4,0 x 40	12
<b>C</b>	18200142		4,0 x 30	20
<b>D</b>	18201122		3,5 x 12	40
<b>E</b>	18401118		Mini Girofix	08
<b>F</b>	18401119		Tambor Mini Girofix	08
<b>G</b>	10500001		Ø6,0 x 30	28
<b>H</b>	18302765		Cor Paina Tapa Furo 18mm	12
<b>I</b>	18306292		Cor Paina Tapa Furo 12mm	37
<b>J</b>	18306085		Cor Branco Tapa Furo 13mm	29
<b>K</b>	18401241		Chapa União	12
<b>L</b>	18404575		Suporte Cabideiro	04
<b>M</b>	18400926		Corrediça Metálica	02
<b>N</b>	18100006		Prego 10 x 10	88
<b>O</b>	18300569		RV8	02
<b>P</b>	18302608		Sapata	10
<b>Q</b>	18437864		Suporte Prateleira	12
<b>R</b>	18201508		4,0 x 30	08
<b>S</b>	18201120		M4 x 25	10
<b>T</b>	18201339		4,0 x 14	100
<b>U</b>	18437859		Vara de Cabide	02
<b>V</b>	16420725		Puxador	04
<b>W</b>	18509797		Dobradiça Alta	20
<b>X</b>	18408727		Porca Sextavada	10

## Guarda Roupa Axis

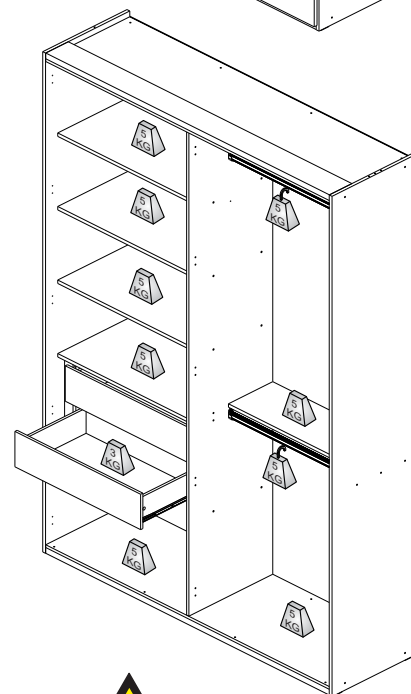
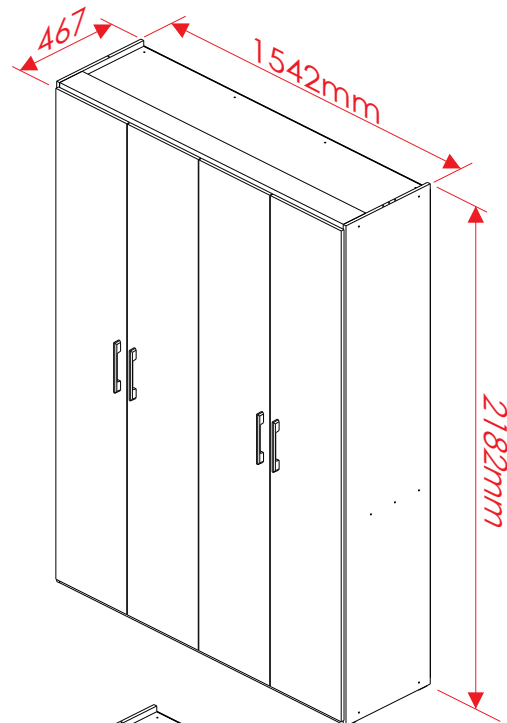

**Atenção!**

**Pesos máximos recomendados com cargas uniformemente distribuídas.**

Utilizar a régua abaixo para medir os acessórios.

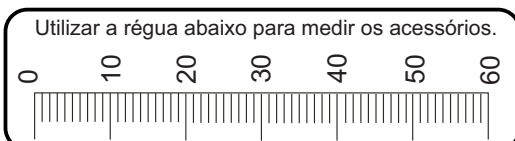

# Componentes

N.	Componentes	Código	Quant.
01	Tampo/Fundo	T17976	02
02	Lateral Esquerda	L09103A	01
03	Rodapé Traseiro	X17182	01
04	Divisão	D03435	01
05	Tampo Gaveta	T17956	01
06	Tampo Estreito	T17970	01
07	Prateleira Móvel	J06074	03
08	Lateral Direita	L09104B	01
09	Complemento Frontal	N01065	02
10	Traseira	F05994	02
11	Porta	P23565	04
12	Cleat	S02526	04
13	Frente de Gaveta	E07967	02
14	Lateral de Gaveta	G07179	04
15	Traseiro de Gaveta	G07178	02
16	Fundo de Gaveta	U02698	02



**Atenção!**

**Forrar o chão com o papelão das embalagens para efetuar a montagem**

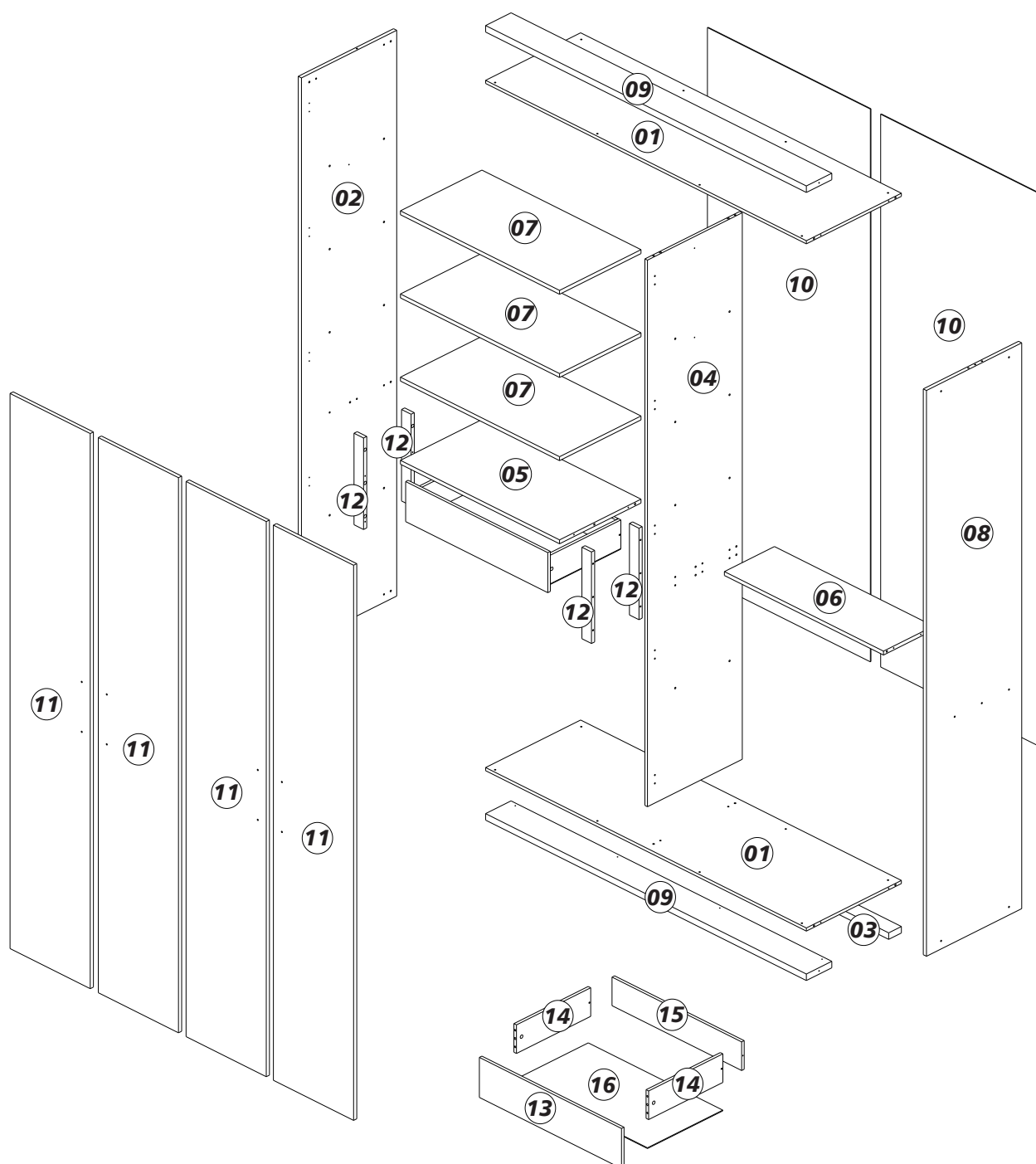
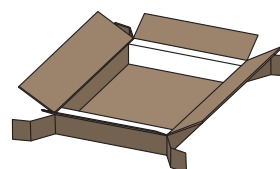

# Componentes - Peças

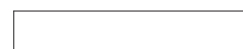
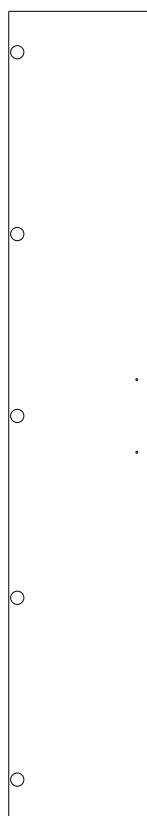
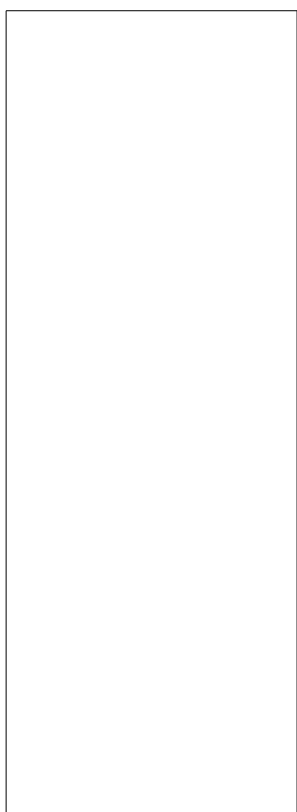
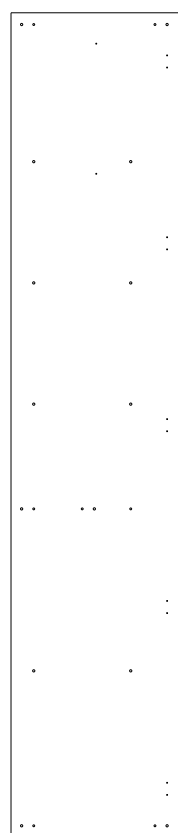
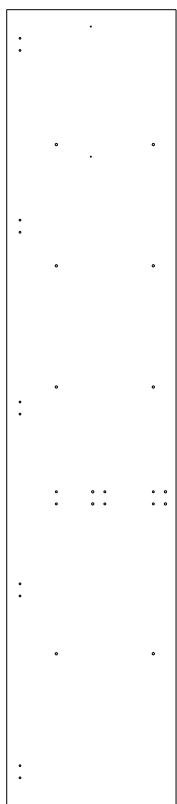
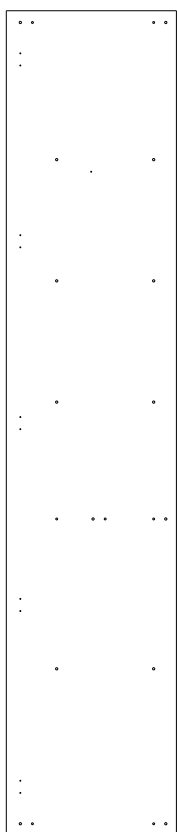
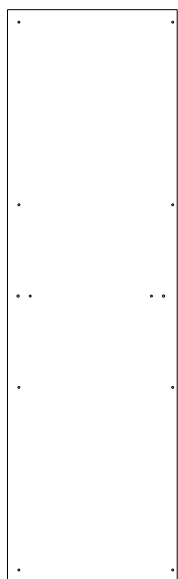

## Opções de Montagem

### Atenção

Este armário possui algumas opções de montagem que estão disponíveis abaixo. Após escolher a opção desejada, escaneie o código QR para acessar o esquema de montagem.

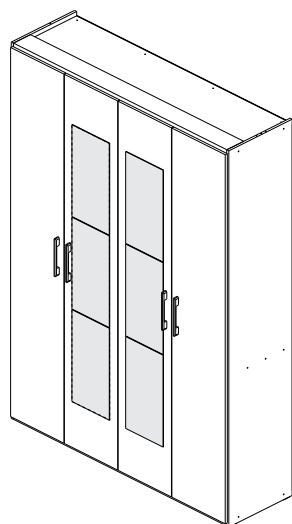
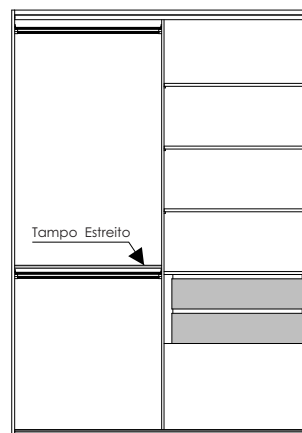
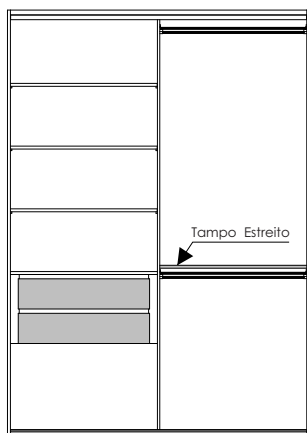

Caso tenha adquirido a versão com espelhos, acesse o esquema de montagem das portas com espelhos com o código QR ao lado.

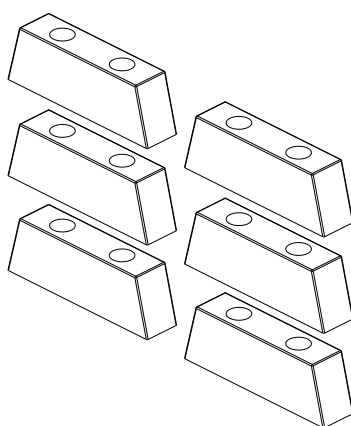

Caso tenha adquirido a versão com pés, acesse o esquema de montagem dos pés com o código QR ao lado.

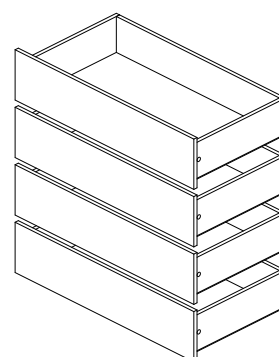

Caso tenha adquirido a versão 4 gavetas, acesse o esquema de montagem das gavetas com o código QR ao lado.



**Atenção!**

Para acessar o vídeo de montagem, você deve abrir a câmera do seu celular e apontá-la para o código QR ao lado.

